

SOLAR ECLIPSE

Ozone plus UV Sanitation System Installation & Operations Manual



IMPORTANT SAFETY INSTRUCTIONS

READ AND FOLLOW ALL INSTRUCTIONS.

- Read this manual completely before attempting installation. Failure to install in accordance with the installation instructions could void warranty and result in injury or death.
- All permanent electrical connections should be made by a qualified electrician.
- A pressure wire connector is provided on the outside of the unit to permit connection to a minimum No. 6 AWG (13.3 mm²) solid bonding conductor between this point and any metal equipment, metal enclosures of electrical equipment, metal water pipes, or conduit within 5 feet (1.5 meters) of the unit as needed to comply with local requirements.
- Install at least 5 feet (1.5 meters) from wall of pool. Install ozone generator no less than one (1) foot above maximum water level to prevent water from contacting electrical equipment. Install in accordance with the installation instructions.
- Follow all applicable electrical codes.
- Electric shock hazard. Be sure to turn power OFF and disconnect from power source before any service work is performed. Failure to do so could result in serious injury or death.
- The Solar Eclipse must be installed in an outdoor location, or indoors in a forced air ventilated room, and installed so that the orientation is exactly as shown in Figure 3. Install to provide water drainage of generator to protect electrical components.
- Mount the Solar Eclipse so that it is inaccessible to anyone in the pool. Never attempt any servicing while unit is wet.
- Warning - Short-term inhalation of high concentrations of ozone and long term inhalation of low concentrations of ozone can cause serious harmful physiological effects. DO NOT inhale ozone gas produced by this device.
- For your safety, do not store or use gasoline, chemicals or other flammable liquids or vapors near this or any other appliance.
- To maintain cosmetic integrity, protect this unit from direct prolonged sunlight exposure.
- To reduce the risk of injury, do not permit children to use this product, unless they are closely supervised at all times.
- **ENVIRONMENTAL NOTICE** - Hg-Lamp CONTAINS MERCURY. Manage in accordance with disposal laws.
See: www.lamprecycle.org

SAVE THESE INSTRUCTIONS!

TABLE OF CONTENTS

SECTION 1 General Information

1A. Description	1
1B. Specifications	1
1C. Warranty Summary	1

SECTION 2 Installation

2A. Pool Prep	1
2B. Location.....	1
2C. Mounting	2
2D. Electrical	2
2E. Plumbing	2

SECTION 3 Operation

3A. Initial System Start-Up	3
3B. Normal Operation.....	3
3C. System Shut-Down	3
3D. Winterizing	3
3E. Water Chemistry	3

SECTION 4 Maintenance & Service

4A. System Electromechanical Overview.....	3
4B. System Maintenance	4
4C. Ozone Module Servicing	4
4D. UV Reactor Service & Maintenance	5

SECTION 5 Trouble Shooting 6

SECTION 6 Contact Information

6A. Contact Information.....	7
6B. Ordering Information	7
6C. Standard Replacement Parts List	7

Warranty	8
----------------	---

SECTION 1 General Information

1A. Description

The Solar Eclipse Ozone and UV Sanitation System described in this manual is designed to provide the benefits of ozonated and UV treated water in an environmentally safe and effective manner. The high quality, specially engineered components ensure efficient water sanitation output and reliable performance. As a result of proper use, the Solar Eclipse virtually eliminates the unpleasant effects of traditional chemicals. The Solar Eclipse ozone generators are safe and harmless to your equipment when installed properly.

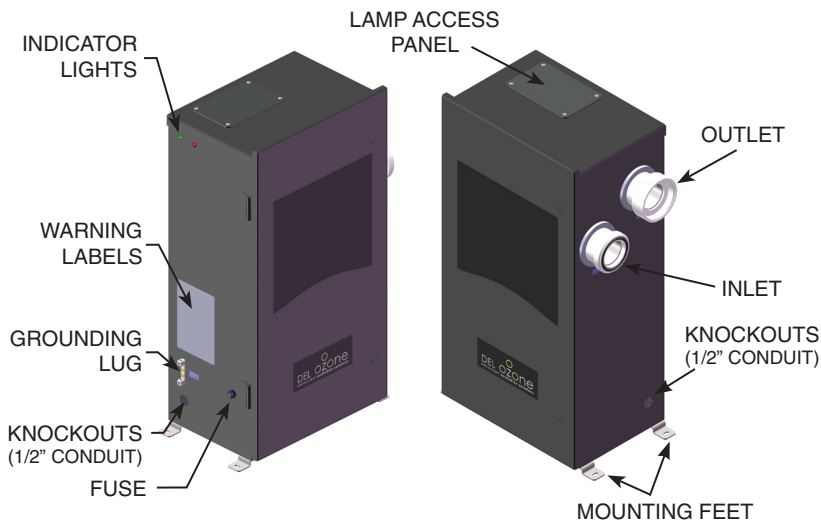

Figure 1: Overview

1B. Specifications

Power Requirements:
240V, 60 Hz, 1Ø, 0.6 Amp

Shipping Weight:
Approx: 54lbs/25.5kg

Location Requirements:
Mounting: Floor Mounted
Ambient Temp.: 30°F - 120°F (0°C - 50°C)

1C. Warranty Summary

Limited Warranty:
Two year limited warranty. See last page for details.

SECTION 2 Installation

2A. Pool Preparation

To achieve optimal performance from the ozone system, the pool must be as clean as possible to start with.

1. Backwash or clean filters one day before starting the ozone generator.
2. Superchlorinate pool water using a chlorine based shock treatment so the water has a sustained 1-3 ppm free chlorine level.
3. Test pool chemistry and adjust pH between 7.4 and 7.6. Adjust total alkalinity between 80 and 120 ppm.
4. Run pool filtration continuously for 24 hours prior to starting ozone system.

2B. Location

The Solar Eclipse unit is designed for floor mounting. Locate the unit in a clean, protected area, either indoors or outdoors (preferably out of direct sunlight). If possible, locate the unit out of reach of sprinklers or drainage spouts. Allow sufficient access for maintenance (2 ft clearance above and 1 ft around the unit) and all plumbing and electrical hookups.

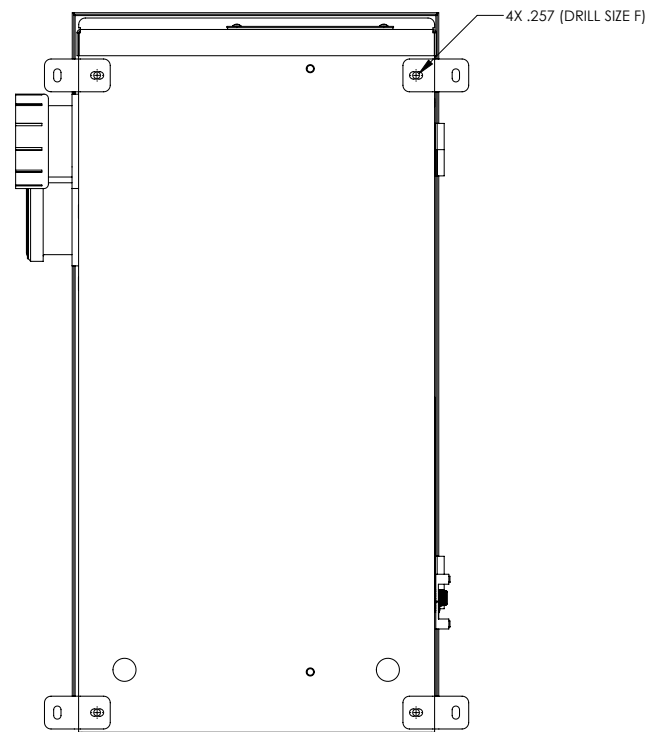

Figure 2: Wall Mounting Hole Pattern

2C. Mounting

2C-1. Floor Mounting

The Solar Eclipse is shipped with the Mounting Feet installed in the floor mounting position. Adjust the position of the feet if necessary and tighten the screws. Mount the Solar Eclipse to the equipment pad through the slots provided in the feet using appropriate hardware for the mounting surface.

2C-2. Wall Mounting

The Solar Eclipse unit does not have holes for wall mounting but can be mounted on the wall if desired.

1. Drill 4 holes, (.257 in, drill size F), in the back of the enclosure approximately as shown in Figure 2.
2. Open door as described in section 4C-1 and clean out debris.
3. Install Mounting Feet in drilled holes with hardware provided.
4. Mount unit to wall through the slots in the Feet using appropriate hardware for the mounting surface.

2D. Electrical

2D-1. Main Power

Connect the Solar Eclipse to the pool timing clock so that the Solar Eclipse operates simultaneously with the pool pump. The Solar Eclipse has four available Knockouts for a 1/2" conduit fitting, two on the back and one on each side. Remove only the ideal Knockout for the installation and install the proper conduit fitting. Remove the Cover (Refer to Section 4C-1) and locate the Terminal Block (Refer to Figure 5) on the left side of the enclosure. Connect Line 1, Line 2, and Ground to the Terminal Block as indicated by the label on the Generator Bracket. Refer to the IMPORTANT SAFETY INSTRUCTIONS at the beginning of this manual for important wiring information.

2D-2. Grounding Lug

Using a solid copper conductor, connect to the Grounding Lug on the left side of the Solar Eclipse to an appropriate earth contact.

2E. Plumbing

The Solar Eclipse can easily be added into the pool's plumbing loop. All the components are contained inside the enclosure so only the water inlet and outlet need to be installed into the pool's return line.

2E-1. Plumbing the Solar Eclipse

The Solar Eclipse must be installed in the pool's main return line after all other pool equipment (pump, filter, heater, and cleaner). Figure 3 shows the most basic installation. For installation with additional sanitizers and pool cleaners contact DEL Technical Support (see Section 6A).

The Solar Eclipse will come with one half of a union fitting installed on Inlet and Outlet, the other half of the fittings will be located in the Solar Eclipse parts bag. Use the union fittings provided to connect the Solar Eclipse inlet and outlet to your pool's plumbing as shown above in Figure 3.

2E-2. Plumbing the Mixing Degas Vessel (optional)

Under normal operation of the Solar Eclipse, bubbles will appear in the return flow to the pool. To remove the bubbles from the flow, an accessory Mixing Degas Vessel, or MDV, can be installed downstream of the Solar Eclipse. The MDV-100 is designed for use with the Solar Eclipse and is recommended on indoor, covered, or vinyl-lined pools. For more information, please call 800-676-1335 and ask for Residential Technical Support.

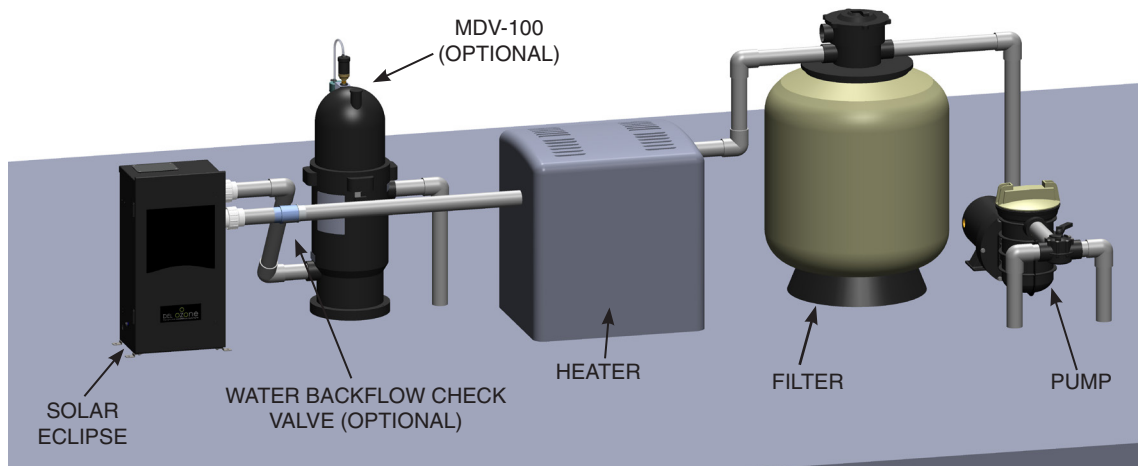

Figure 3: Solar Eclipse Location in Pool Loop

2E-3. Water Backflow Check Valve

If the pool equipment is mounted above the water line, a check valve must be installed between the pump outlet and the Injector Manifold to prevent the pump from draining and losing its prime (when not in use).

Note: If a 1/3# DELCheck™ is used, do not install immediately after chlorine feeders.

SECTION 3 Operation

3A. Initial System Start-Up

Upon completing all of the system connections and cleaning the pool as outlined in Section 2, you are ready to start the Solar Eclipse.

1. Check electrical connections.
2. Turn on pool circulation system and verify the Solar Eclipse has power.
3. Remove cover. Confirm that fittings are not leaking, contact Tech Support (Section 6A) if leaks are found.
4. Replace cover.

3B. Normal Operation

Indicator Lights: The Solar Eclipse has two external indicator lights, red and green, on its left side. When the Solar Eclipse has power, the green Power Light will illuminate. The red Flow Indicator may be on momentarily. Once adequate water is flowing, the red Flow Indicator will go out. If the red Flow Indicator light is still lit after the pump has reached steady flow, refer to Trouble Shooting (Section 5).

3C. System Shut-Down

The following sequence of steps must be followed for servicing or for storage.

1. Shut off power at the breaker.
2. Shut off water to the unit.
3. Open door.
4. Disconnect all electrical, plumbing, and mounting connections for storage.

3D. Winterizing

If the pool will be shutting down for the winter months and the Solar Eclipse will remain exposed to freezing temperatures, the unit must be drained to prevent freeze damage to the wetted components. To drain the Solar Eclipse, see the following steps.

1. If the Solar Eclipse is mounted below the water level, bypass valves must all be CLOSED to prevent excess water from draining into the unit.
2. Open the door.
3. Locate the Drain Plug (Refer to Figure 6) and remove to drain the remaining water in the Solar Eclipse.
4. Allow all the water to drain from the Solar Eclipse before threading the plug back into the UV Reactor.

3E. Water Chemistry

Regular chlorine testing should be performed as normal. Ozone will be eliminating the majority of contaminants. Therefore, only a small amount of chemicals will need to be added – just enough to maintain a residual level of 0.5 - 1.0 ppm free chlorine. Ozone is pH neutral and will not cause pH or total alkalinity fluctuations.

SECTION 4 Maintenance & Service

4A. System Electromechanical Overview

Refer to Figures 4, 5, and 6.

4A-1. Ozone Module

The Solar Eclipse is constructed with 6 Corona Discharge Ozone Modules. Each Ozone Module has a green light to indicate that the Ozone Power Supply is operating properly. (Refer to Figure 5 for a more detailed view)

4A-2. Ultraviolet Lamps

There are two lamps in the UV Reactor of the Solar Eclipse. If the UV Lamp Access Panel is removed while the unit is running, a slight glow can be seen near the top of the lamps. (Refer to Figure 6 for a more detailed view)

4A-3. Injector Manifold

Water flowing through the Injector Manifold generates the vacuum that draws ozone into the water. The DELCheck™ spring loaded valve automatically adjusts for various water flow rates to keep the Solar Eclipse operating over a wide range of conditions.

4A-4. Ozone Gas Line

Gas from the Ozone Modules is drawn through the Ozone Gas Line by the Injector and into the water. The Ozone Check Valve in this line prevents water from migrating back to the Ozone Modules when the Solar Eclipse is not running.

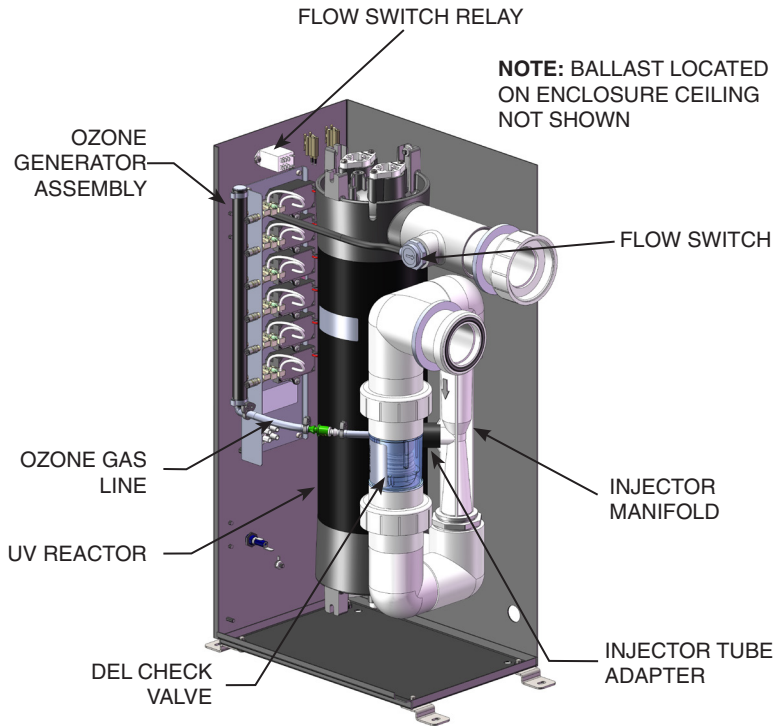

Figure 4: Solar Eclipse Electro-Mechanical Overview

4A-5. Ozone Module Filters and Orifice

The air entering the Ozone Modules passes through individual Filters and an Orifice on each Module inlet. The Filters and Orifices are held in place by the rubber Filter Cap. (Refer to Figure 5 for a more detailed view)

4A-6. Injector Tube Adapter

This connects the Ozone Gas Line to the Injector Manifold. When servicing this component, do not tighten past 10 in-lbs or the component may be damaged.

4B. System Maintenance

All system maintenance must be performed with either the UV Access Panel or Enclosure Cover removed. You will need a size 2 phillips head driver to remove these components

4B-1. Ozone Module Maintenance

The green Ozone Module Lights on the Ozone Modules indicate that the Ozone Power Supply is operating properly. When an indicator light goes out, replace the corresponding Ozone Module.

4B-2. Ozone Module Replacement Interval

Ozone module life expectancy is 5 years. Even if the Ozone Module Light(s) are glowing, the Ozone Module may be producing little or no ozone after this period of time due to contamination within the corona discharge ozone chamber.

4B-4. Ozone Gas Line Replacement Interval

Replace the Ozone Gas Line every year or sooner, if needed. If there is evidence of water leaking past the Ozone Check Valve toward the Ozone Modules, shut down the Solar Eclipse immediately and replace the Ozone Gas Line. If water entered the Ozone Modules, run the filtration system so air will be drawn through the Ozone Modules and they can dry out. Ozone Modules will return to normal operation when dry.

WARNING: Trace amounts of nitric acid may be present in the Ozone Gas Line. Wear proper safety equipment (gloves and eye protection) and avoid direct contact with any condensation in the line.

4C. Ozone Module Servicing - Refer to Figure 5

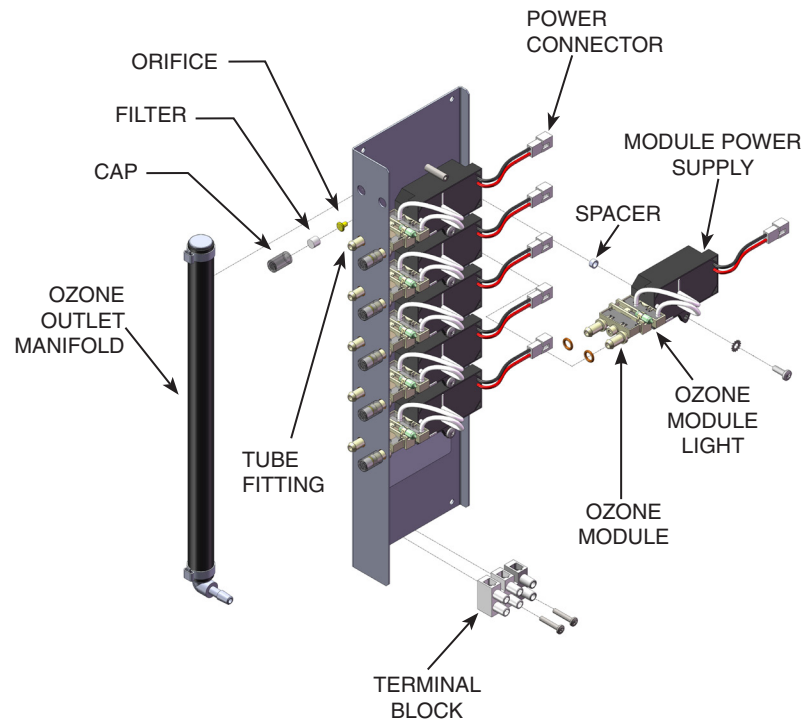

Figure 5: Ozone Generator Subassembly

4C-1. Opening the Door

The Solar Eclipse may be serviced without disconnecting any of the plumbing or wiring. Simply use a slotted screwdriver to turn the door latches a half turn counter clockwise and open the door. Reverse the steps to securely close the door.

4C-2. Replacing an Ozone Module

1. Open the Solar Eclipse as described in Section 4C-1.
2. Locate the Ozone Modules on the left wall of the enclosure.
3. Remove the Filter Cap Assembly from the right tube fitting of the Ozone Module. Make sure you keep the Cap, Filter and Orifice together.
4. While holding the Ozone Outlet Manifold, gently pull the left tube fitting out of the manifold and both tube fittings through the holes in the Ozone Module Bracket. Let the Ozone Module hang down.
5. Disconnect the Ozone Gas Line and unscrew the two front mounting screws of the Ozone Bracket. Swing the ozone Bracket forward and locate the Power Connector (black and red wires) from the Module Power Supply and disconnect from the wire harness. Refer to Figure 6.
6. Unscrew the Ozone Module from the Module Bracket and remove the Module assembly from the unit.
7. Install the new Ozone Module by reversing the above steps. Refer to Figure 5 for visual instruction. Do not misplace spacer.

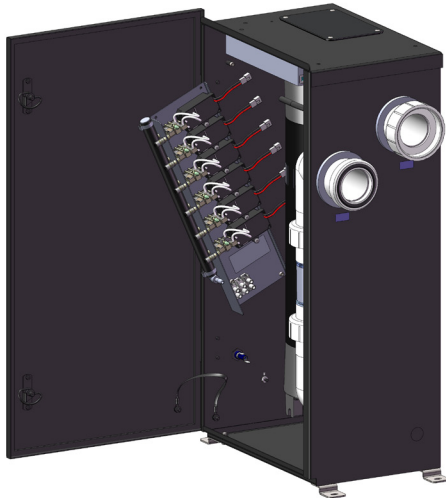

Figure 6: Ozone Bracket During Ozone Module Service

4D-1 Lamp Removal

1. Locate the UV Lamp Access Panel on the top of the Solar Eclipse, remove the 4 screws with a Phillips head screwdriver, and remove the panel.
2. After allowing adequate time for the lamps to cool, disconnect the Lamp Connectors from Ballast wires.
3. Grasp the UV Lamp wires and gently pull until the top of the UV Lamp has pulled past the Lamp Retainer tabs.
4. By holding the UV Lamp's white ceramic end, slowly pull the UV Lamp until the bottom has pulled past the Lamp Retainer tabs. **DO NOT TOUCH THE UV LAMP GLASS WITH YOUR BARE HANDS.** Oils on your hands can cause hot spots on the UV Lamp and shorten its life. Use a soft clean cotton cloth or clean cotton gloves to handle the UV Lamp. Carefully place the UV Lamp in a clean, dry, and safe location. Repeat this process for the other UV Lamp.

4D-2 Quartz Tube Removal and Cleaning

Note: If the Solar Eclipse is installed below water level, the bypass valves must all be CLOSED to prevent excess pool water from draining into the open unit when a Quartz Tube is removed.

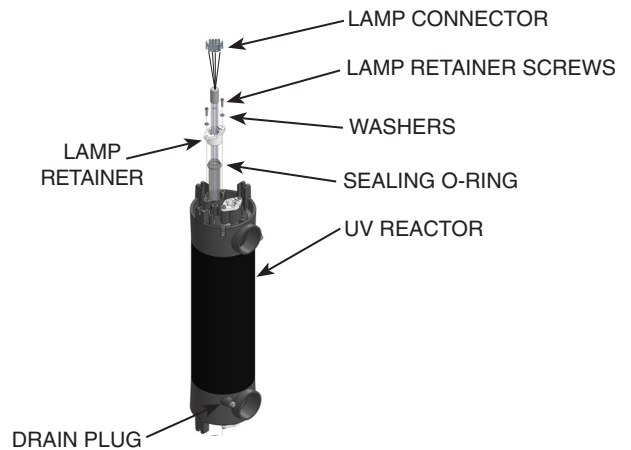

Figure 7: UV Reactor Subassembly

4D. UV Reactor Service and Maintenance

The UV Lamps are housed in a Quartz Tube. If the Quartz Tube becomes dirty, its ability to transmit UV rays from the Lamp will be diminished. The Quartz Tube(s) should be removed from the UV Reactor every six (6) months and cleaned if necessary.

1. Before continuing, allow adequate time for the Quartz Tubes to cool and drain the water from the UV Reactor by removing the Drain Plug and replacing it once water has stopped exiting the UV Reactor.
2. After removing the lamps, remove the top Lamp Retainer Screws using the hex key included in the parts bag. Place the Lamp Retainer Screws, Washers, and the Lamp Retainer aside in a safe place.

3. Using the hex key included in the parts bag, loosen the bottom Lamp Retainer Screws two full rotations.
4. Grasp the Quartz Tube from the top of the UV Reactor, and pull to remove it from the UV Reactor.
5. Remove the Sealing O-Ring from the top of the Quartz Tube and set aside in a safe place.
6. Clean the Quartz Tube exterior with a mild solution of muriatic acid (available at all pool supply stores) and water in a ratio of four parts water to one part acid (4:1).

CAUTION: Follow the directions for use and handling of muriatic acid on the acid bottle label, being careful to protect your eyes, wear rubber gloves, and avoid breathing acid fumes.

NOTE: DO NOT USE ABRASIVE CLEANERS as they can scratch the high quality quartz glass. If lime or hardwater calcium deposits are encountered, use household tub and shower lime removal. After cleaning the Quartz Tube, wash it off and wipe dry. Inspect the Quartz Tube for cracks. Replace if cracks are found. Make sure the inside of the Quartz Tube is dry before replacing the UV Lamp(s).

NOTE: DAMAGES CAUSED BY BROKEN QUARTZ TUBES ARE NOT COVERED UNDER YOUR LIMITED WARRANTY.

4D-3 Quartz Tube Installation

1. While holding the Quartz Tube so it is oriented straight up and down, insert the Quartz Tube into the UV Reactor until it is fully seated in the bottom of the UV Reactor.
Note: If the end of the Quartz Tube is protruding from the UV Reactor, the alignment is off. Remove and re-insert the Quartz Tube to seat it properly as shown in Figure 8.
2. Place a Sealing O-Ring approximately 1/2in (12.7mm) from the end of the Quartz Tube protruding from the top of the UV Reactor.
3. Place the Lamp Retainer over the Quartz Tube and using the hex key included in the parts bag, attach the Lamp Retainer to the UV Reactor using the Lamp Retainer Screws and Washers as shown in Figure 7. Make sure the Lamp Retainer flanges are fully seated against the UV Reactor.
Turn the circulation pump ON and check the Quartz Tube seal for leaks.
4. Turn the circulation pump OFF once you have confirmed that the Quartz Tube is not leaking.

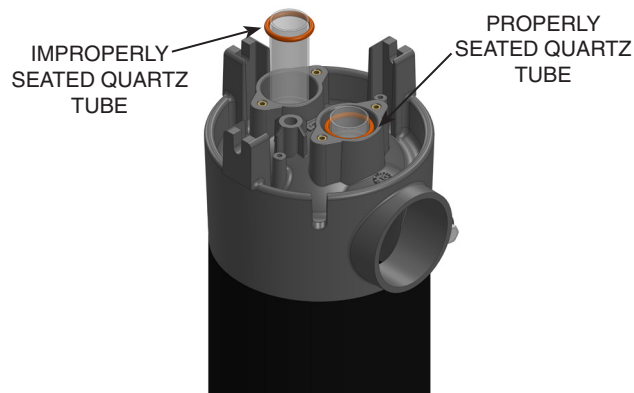

Figure 8: UV Quartz Tube Installation

4D-4 Re-installing the UV Lamp(s)

NOTE: Make sure to handle the UV lamp as described in section 4D-1.

1. TURN OFF YOUR PUMP IF YOU HAVE NOT DONE SO.
2. Slowly press the UV Lamp fully past the Lamp Retainer tabs and into the Quartz Tube until it is seated on the Lamp Cushion in the bottom of the tube.
3. Connect the Lamp Connector to the connector on the Ballast

NOTE: To replace a UV Lamp, follow only Sections 4D-1 and 4D-4

ENVIRONMENTAL NOTICE - Hg-Lamp CONTAINS MERCURY. Manage in accordance with disposal laws. See: www.lamprecycle.org

SECTION 5 Trouble Shooting

Knowledge of electrical applications is required for trouble shooting. Contact a certified electrician if you are unsure of your ability to service the equipment. Improper servicing will void generator warranty. If any condition persists contact DEL Technical Support (see Section 6A).

Symptom: Green Indicator not lit when pool system is on.

1. No power to the Solar Eclipse from the Power Source:
 - a. Check circuit breaker at the power distribution box.
 - b. Check for loose connections or wiring breaks in the lines leading to the Terminal Block.
 - c. Fuse in the unit has blown and needs to be replaced. Fuse is a 1 Amp slow blow, 1/4" x 1.25" long, glass fuse.
 - d. Indicator lights have burnt out.

Symptom: Red Indicator will not go out.

1. Insufficient flow through Solar Eclipse.
 - a. Verify that pump is running properly and that filter and skimmers are clean.
 - b. Clear any blockages in return line.
2. Flow Switch has failed and needs to be replaced.
3. Flow Switch Relay has failed and needs to be replaced.

Symptom: Green Ozone Module Light is not illuminated when unit is running.

1. This means that the power supply of that specific Ozone Module is no longer drawing power and needs to be replaced. Refer to Section 4C-2 for instructions on how to replace the corresponding Ozone Module.

Symptom: One or both the UV Lamps are not lit when unit is running.

1. Check Lamp Connector Plug for complete connection.
2. Water fouling has shorted lamp connections.
3. Bad UV Lamp.
4. Bad Ballast.

SECTION 6 Contact Information

6A. Contact Information:

For technical assistance:

Call: (800) 676-1335 and ask for Residential Technical Support.

Email: warrantysupport@delozone.com

Or visit our website: www.delozone.com

Be prepared with the following information:

- Name
- Address
- DEL Model #
- Date Purchased

6B. Ordering Information:

To locate a dealer nearest you call 1.800.676.1335, ext. 232 or visit www.delozone.com.

6C. Standard Replacement Parts List

1. UV Lamps (18 months) 9-1197-01
2. Ozone Gas Line (1 year)..... 9-1087-01
3. Ozone Cell (5 years) 9-1056-01

Note: The warranty is void if the parts listed above are not replaced at recommended intervals.

DEL OZONE Solar Eclipse™ LIMITED WARRANTY

The limited warranty set forth below applies to products manufactured by DEL OZONE – 3580 Sueldo Street, San Luis Obispo, California 93401, and sold by DEL OZONE or its authorized dealers. This limited warranty is given only to the first retail purchaser of such products and is not transferable to any subsequent owners or purchasers of such products.

DEL Ozone warrants that it or its authorized dealers will repair or replace, at its option, any part of such products proven to be defective in materials or workmanship within:

- Two (2) years from the date of retail purchase of such products, all parts except:
- Eighteen (18) months on UV Lamps
- Twelve (12) months on Ozone Gas Line and Ozone Check Valve assembly

ANY REPAIR OR REPLACEMENT WILL BE WARRANTED ONLY FOR THE BALANCE OF THE ORIGINAL WARRANTY PERIOD.

NOTE: USE ONLY DEL AUTHORIZED DEL REPLACEMENT PARTS. USE OF ANY OTHER PART(S) WILL VOID THIS WARRANTY.

Any replaced parts must be returned to DEL OZONE for warranty evaluation.

THIS LIMITED WARRANTY DOES NOT INCLUDE ANY OF THE FOLLOWING:

- (a) Any repair or replacement of such parts necessitated by faulty installation, improper maintenance, improper operation, misuse, abuse, negligence, accident, fire, flood, repair materials, and/or unauthorized accessories.
- (b) Any such products installed without regard to required local codes and accepted trade practices.
- (c) Damage to unit caused by water backflow;
- (d) Any implied warranty of merchantability or implied warranty of fitness for particular purpose, and such warranties are hereby disclaimed.
- (e) DEL Ozone shall not be liable under any circumstances for loss of use of such product, loss of profits, direct damages, indirect damages, consequential damages, and / or incidental damages.

This warranty gives you specific legal rights. You may have other rights which vary from state to state.

TO OBTAIN WARRANTY SERVICE:

DEL OZONE
3580 Sueldo, San Luis Obispo, CA 93401
Customer Service Number: (800) 676-1335 x 293
Fax Number: (805) 597-5452
E mail: warrantysupport@delozone.com

PROVIDE:

1. Customer name, mailing address, and telephone.
2. Installer/Mechanical Contractor or Dealer name.
3. Unit Part Number, Serial Number or Manufacture Date, and date of purchase.
4. The date of failure.
5. A description of the failure.

After this information is provided, DEL Ozone may release a *RETURN GOODS AUTHORIZATION (RGA) NUMBER*. After receiving the RGA number the part in question must be returned to DEL Ozone, freight prepaid, with the RGA number clearly marked on the outside of the package. All preauthorized defective parts must be returned to DEL Ozone within thirty (30) days. Under no circumstances may any product be returned to DEL Ozone without prior authorization. Returns without the assigned RGA number on the outside of the package will be refused and shipped back to the sender at their expense. Upon receipt of preauthorized returned goods, DEL Ozone will repair or replace, at DEL Ozone's option, the defective product(s) and return them (freight prepaid for products under warranty). Buyer's acceptance of the product and use thereof constitutes acceptance of these terms.

4-2006-01_Rev.A



3580 Sueldo Street, San Luis Obispo, CA 93401 | 800.676.1335 | o3info@delozone.com | www.delozone.com
EPA Estab. No. 071472-CA-001